

RoHS
Compliant

Oval ring drawing:

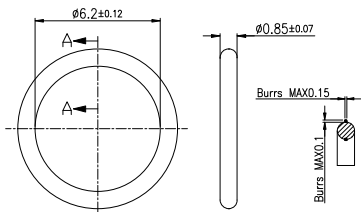

注防水圈要求组装在产品上。
Note: The waterproof ring shall be assembled on the product

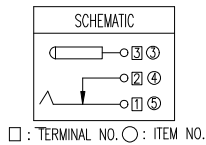

SPECIFICATIONS:

- ELECTRICAL CHARACTERISTICS:
 - RATING: 30V DC /1A
 - CONTACT RESISTANCE: 30mΩ MAX.(INITIAL)
 - DIELECTRIC WITHSTANDING VOLTAGE: 300V AC FOR ONE MINUTE.
 - INSULATION RESISTANCE: 100MΩ MIN. MEASURED BY 500 VDC
- MECHANICAL CHARACTERISTICS:
 - INSERTION FORCE : 0.5kgf~2.5kgf
 - WITHDRAWAL FORCE : 0.5kgf~2.5kgf
- DURABILITY: 5,000 CYCLES .
- WATER PROOFNESS:THIS PRODUCT IS BASED ON IPX8(2M,30min)
- PLUG INTERFACE DIMENSIONS COMFORM TO USB2.0 SPEC.
- OVAL RING
 - The amount of low molecular siloxanes(D3~D10)is less than 200ppm
 - Hardness of silicone rubber:70°
- FOR REFLOW SOLDERING LEAD-FREE PROCESS.
- PACKAGING: TAPE & REEL.

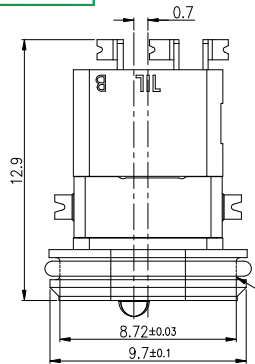

防水部メッシュライン全体
・金型段差が0.02MM以下
・端面処理要求Ra0.2um以下
(目標はRa0.1um)

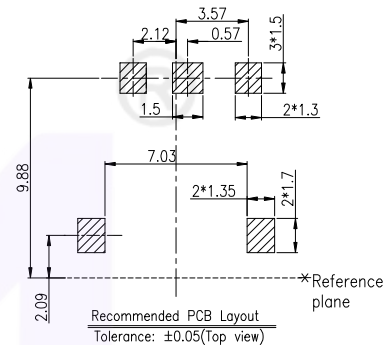
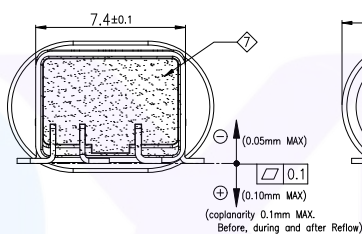
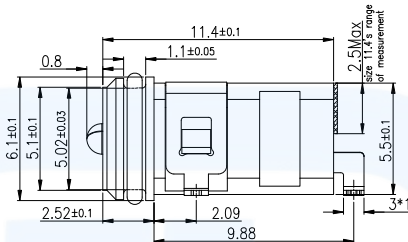
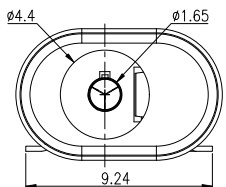

CASE INTEGRATION CONDITION

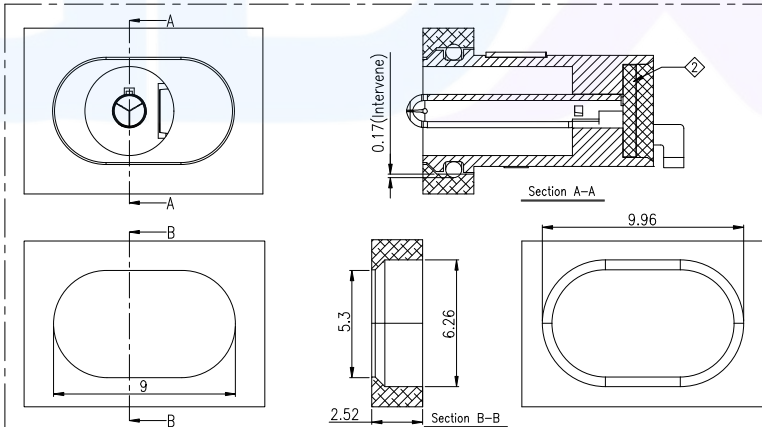

UNLESS OTHERWISE SPECIFIED, TOLERANCE ON DECIMAL:±0.3

ITEM	PART NAME	TERMINAL	QTY	MATERIAL	REMARK
①	O-RING	---	1	---	---
②	BOND	---	1	---	---
③	SHELL	---	1	C2680 T=0.25	Overall : Nickel-underplated(1um MIN) Outer plating: Sn-plated(2um MIN)
④	TIP SPRING	①	1	Ti-Cu T=0.25	Overall : Nickel-underplated(1um MIN) Outer plating: Sn-plated(2um MIN)
⑤	SHNUT	②	1	C2680 T=0.25	Overall : Nickel-underplated(1um MIN) Outer plating: Sn-plated(2um MIN)
⑥	CENTER PIN	③	1	C2680 T=0.3	Overall : Nickel-underplated(1um MIN) Outer plating: Sn-plated(2um MIN)
⑦	CAP	---	1	LCP(E130i,BLACK)	UL94 V-0
⑧	HOUSING	---	1	LCP(E130i,BLACK)	UL94 V-0

广东小迈实业有限公司

Website:

<https://www.xmconn.com>

TEL:

18938295888



PART NAME

DC JACK Waterproof Connector

PART NO.

DM44165-05SBAP-A

TOLERANCE UNLESS OTHERWISE SPECIFIED:

X ±0.2
X.X ±0.15
X.XX ±0.10
X.XXX ±0.050

DRAWING:

Li

DATE:

2023.08.18

SCALE

SHEET

REV: A0

CHECK:

Chen

DATE:

2023.08.18

1:1

1/1

SIZE: A4

APPROVAL:

Wen

DATE:

2023.08.18

